

## Motor Comparison for 151-0314

Category	Existing Model	Replacement Model
Material Number	151-0314	11186705
Basic Motor	OMP	OMP X
Displacement	160	160
Series	8	X
Active	Yes	Yes
Mounting Flange	A2	A2
Mounting Thread Dimension	None	None
Shaft Style	Cylindrical	Cylindrical
Shaft Size	25 mm	25 mm
Shaft Key	A8 x 7 x 32 mm (DIN 6885)	A8 x 7 x 32 mm (DIN 6885)
Port Style	Side port - Offset	Side port - Offset
Port Dimension	G 1/2	G 1/2
Drain Port Style	None	Standard
Drain Port Dimension	None	G 1/4
Brake Release Port	None	None
Brake Release Port Dimension	None	None
Painted	None	None
Special Features External 1	None	None
Special Features External 2	None	None
Special Features External 3	None	None
Dust Seal	Standard - HPS	Int. in shaft seal
Shaft Seal	HPS - 200	HPS - 225
Seal Kit	151-1286	11188319
Front Bearing	Journal bearing	Journal bearing
Rear Bearing	Journal bearing	Journal bearing
Gear Wheel Set	Standard	Standard
Check Valve	No	Yes
Valve Function	None	None
Special Features Internal 1	None	None
Special Features Internal 2	None	None

Packing	Single pack	Single pack
Option Type	Standard	Standard

## Technical Data Comparison for 151-0314

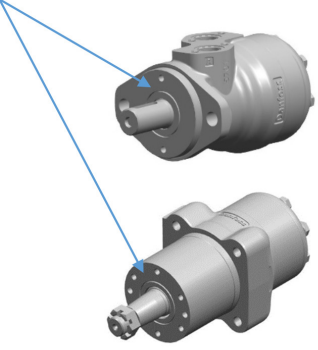

Category	Existing Model	Conversion Model
Type	OMP	OMP X
Motor size	160	160
Geometric displacement	155.7 [9.53]	155.7 [9.53]
Max speed cont	385	385
Max speed int	480	480
Max torque cont	300 [2660]	335 [2965]
Max torque int	370 [3280]	425 [3760]
Max output power cont	10.2[13.7]	11.4 [15.3]
Max output power int	12.3[16.4]	13.5 [18.1]
Max pressure drop cont	140 [2030]	160 [2320]
Max pressure drop int	175 [2540]	200 [2900]
Max pressure drop peak		
Max oil flow cont	60 [15.9]	60 [15.9]
Max oil flow int	75 [19.8]	75 [19.8]
Max start pressure with unloaded shaft	7 [100]	7 [100]
Min start torque at max press drop cont	280 [2480]	320 [2830]
Min start torque at max press drop int	350 [3100]	400 [3540]
Max inlet pressure cont	175 [2540]	200 [2900]
Max inlet pressure int	200 [2900]	225 [3260]
Max inlet pressure peak		
Max return pressure with drain line cont	175 [2540]	200 [2900]
Max return pressure with drain line int	200 [2900]	225 [3260]
Max return pressure with drain line peak		
Holding torque		
Min brake release pressure		
Max pressure in brake line		
Max pressure in drain line		

# Fit and Appearance

<p>Illustration AB – Is</p> <p>OMP / OMR / DH / DS OMPW / OMPW N</p> <p>None seal guard groove</p> 
<p>Illustration AB – Will be</p> <p>OMP X / OMR X OMPW X / OMPW X N</p> <p>All motors will have a seal guard groove in the front cover</p> 



App\_AB\_v1

App\_AB\_v1

<p>Illustration AF – Is</p> <p>OMP / OMR / DH / DS OMPW / OMPW N</p> <p>Product label incl. bar code</p> 
<p>Illustration AF – Will be</p> <p>OMP X / OMR X OMPW X / OMPW X N</p> <p>Product label incl. bar code and data matrix code</p> 

App\_AF\_v1

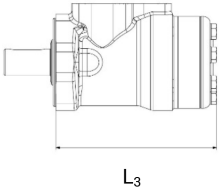
App\_AF\_v1

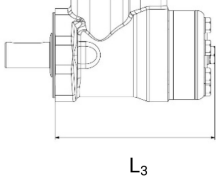
Illustration AP – Is	Illustration C – Is
OMP / OMR / DH / DS OMPW / OMPW N	OMP / OMPW / OMPW N without drain connection
<p>Current packaging insert for the cardboard box.</p> 	
Illustration AP – Will be	Illustration C – Will be
OMP X / OMR X OMPW X / OMPW X N	OMP X / OMPW X / OMPW X N with drain connection
<p>Improved packaging insert for the cardboard box.</p> <p>The new carton made of paper pulp is an environmental friendly material – 100% recyclable, biodegradable and compostable.</p> <p>In the current packaging solution, the oil is softening the packaging box.</p> <p>The new paper pulp carton is form resistant to oil.</p> 	<p>L<sub>3</sub> will be max 5,5 mm [0.22] longer</p> 

Fit\_C\_v1

Fit\_C\_v1

App\_AP\_v1

App\_AP\_v1

Illustration CCC – Is

OMP / OMR / DH / DS / OMPW / OMPW N

OMP and OMR – 200 bar shaft seal

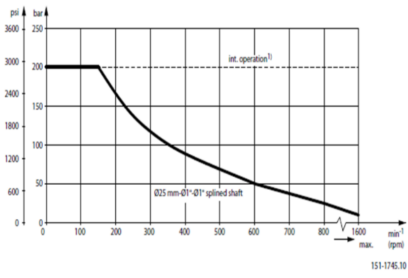
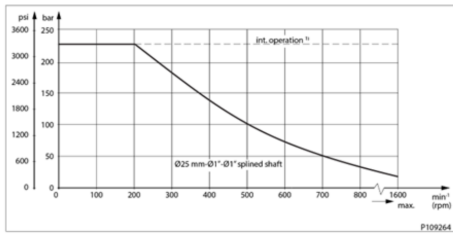

Illustration CCC – Will be

OMP X / OMR X / OMPW X / OMPW X N

OMP X and OMR X – 225 bar shaft seal



Fun\_CCC\_v1

Fun\_CCC\_v1