

TECHNOLOGY IN MOTION

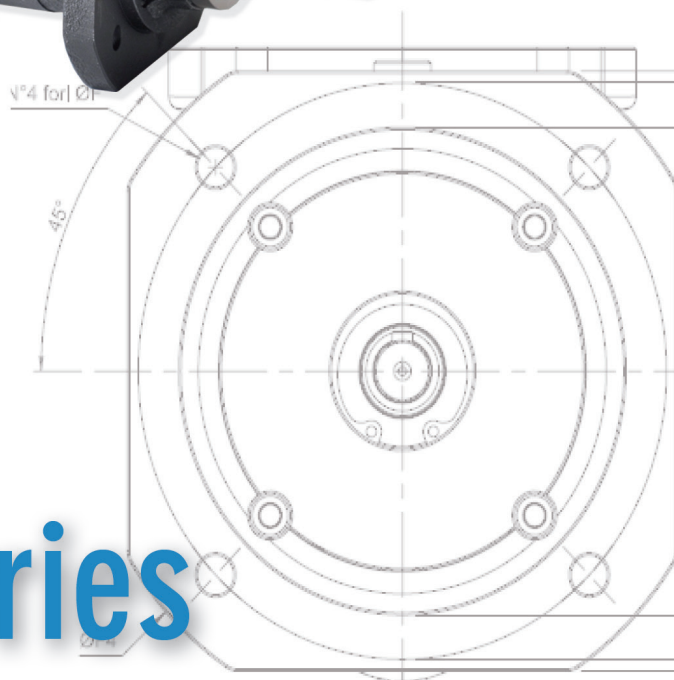

MARINE

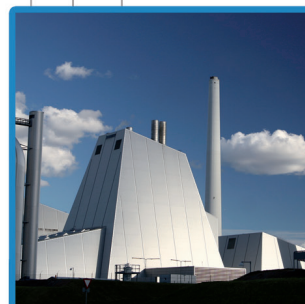

POWER GEN

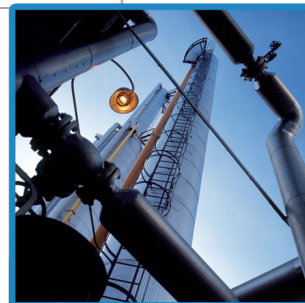

INDUSTRIAL

SFO series

Fuel oil handling pump

(Marine - Power gen - Industrial)

LUBRICATION - CIRCULATION - TRANSFER

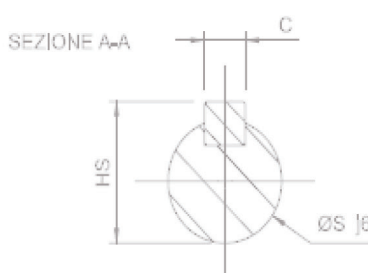
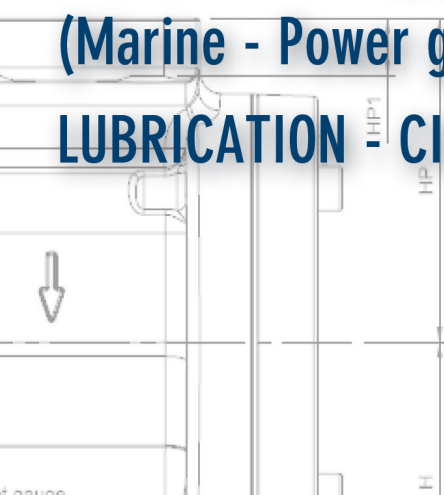

SFO Pump series



In **SFO pump** the fluid has a uniform axial flow, which drives to a minimum of fluid pulsation and extremely quiet operation. **SFO pump** has been designed for handling non-aggressive fluid with sufficient lubricating properties.

SFO pump is the ideal pump for lubrication, circulation and transfer lubrication of diesel engines, hydro turbines, paper machines and other machine tools, gears, gas and steam turbines.

Circulation for filtration and cooling, engine fuel filtration and boosting (ships and power plants), hydraulic systems and oil transformers for insulation, transfer onboard, refineries, oil factories etc.

When required, **SFO pump series** may be certified according to the most common classification societies: DNV, BV, LRS, ABS, RS, GL, RINA, KR, NK or CCS. **SFO pump** can be equipped with one of the following solutions: lip seal, double seal (lip seal + mechanical seal), magnetic coupling.

Magnetic coupling sealless pump - FGM option

A hermetically sealed **magnetic coupling** is available (as option) for all model of **SFO pump series**.

It is a permanent magnetic synchronous coupling able to transmit torque through magnetic forces between the internal and external rotors. Applying a **magnetic coupling**, the drive and the driven sides are hermetically separated.

In case of critical media the **magnetic coupling** is a reliable seal and avoid any leaking.

The **magnetic coupling** comes with a containment shroud that is fixed to the pump and separates internal and external rotors from each other. Due to the absence of mechanical connection the vibration torque transmission is very low, with completely leak-proof separation of product and atmosphere.

The **magnetic coupling** is used to ensure no media leaking when working in environments with potentially explosive atmospheres or with high temperature fluids.

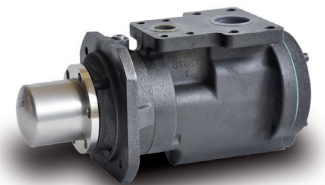

Applications

POWER

Lubrication of diesel engines, hydro turbines, gas and steam turbines

Hydraulic systems and insulation oil for transformers

Circulation for filtration and cooling, engine fuel filtration and boosting (power plants)



MARINE

Circulating for filtration and cooling

Engine fuel filtration

Engine fuel boosting

Burner boosting systems

Burners injection

Transfer onboard

Refineries



INDUSTRIAL

Lubrication of diesel engines

Paper machines

Machine tools

Thermal oil

Oil factories

Centrifugal compressors

Transmission gears

Rotating machinery

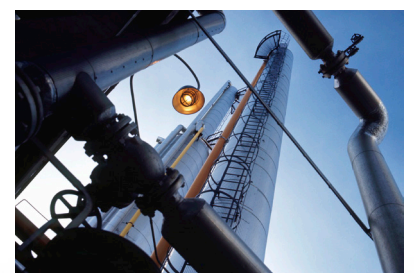

Technical characteristics

PRESSURE RELIEF SECURITY VALVE: SFO pump can be equipped, upon request, with a Relief Security Valve, with the principal scope to protect the pump and limiting the differential pressure across the pump. The security valve is adjustable to reduce or enlarge the opening pressures (adjustable between 5 and 15 bar).

PUMP ROTATION: SFO pump is designed to operate, as standard, clockwise (clockwise when in front of the shaft end). For the opposite rotation please contact Settima.

DRIVE: SFO pump can be connected to an electrical motor also by a magnetic coupling (please contact Settima).

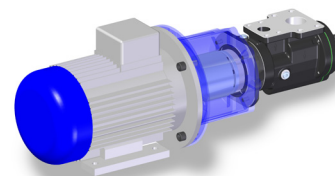

Standard type and options

	Standard	Options
Pressure valve	With no relief valve	External variable regulation valve
Corrosion preservation	Phosphating	Varnishing upon request
Seal guard	-	Dispenser for seal guard
Connections	-	SAE 3000

Technical characteristics

Models / Modelli	25 - 32 - 40	
Drive loading / Carichi	No axial or radial loads / Nessun carico assiale o trasversale	
Shaft rotation / Rotazione albero	Clockwise (from shaft end) / Destra	
Shaft speed Velocità di rotazione	From 500 to 3.600 rpm* / Da 500 a 3.600 rpm*	
Flows / Portate	From 12 up to 75 L/min (at 1.450 rpm) / Da 12 a 75 L/min (a 1.450 rpm)	
Outlet pressure Pressione di mandata	20 bar continous - 40 bar intermittent 20 bar continuo - 40 bar ad intermittenza	
Inlet pressure Pressione di aspirazione	Min. -0.7 bar max. 1.5 bar (for higer pressure please contact Settima) Min. -0.7 bar max. 1.5 bar (per pressioni maggiori contattare Settima)	
Fluids / Fluidi	Mineral oil, synthetic oil, oil water emulsions, fuels, marine distillate fuels, marine residual fuels	
Viscosity / Viscosità	**Down to 2 cSt / **Minimo 2 cSt	
Seals Guarnizioni	Lip seal: NBR, Viton, EPDM (others on request) Mechanical seal Lip seal + Mechanical seal	Guarn. a labbro: NBR, Viton, EPDM (altro su richiesta) Tenuta meccanica Guarnizione a labbro + Tenuta meccanica
Acoustic emissions Emissioni acustiche	From 50 up to 58 db(A) at 2.950 rpm / Da 50 fino a 58 db(A) a 2.950 rpm	
Pump body / Corpo	Cast iron GJL-250 EN 1561 / Ghisa GJL-250 EN 1561	
Screw / Viti	Steel (central steel, lateral cast iron on request) / Acciaio (acciaio vite centrale, ghisa viti secondarie su richiesta)	
Enviroment temperature Temperatura ambiente	From -20°C up to +50°C / Da -20°C a +50°C	
Hydraulic temperature Temperatura olio	From -20°C up to +155°C / Da -20°C a +155°C	
Filtration / Filtrazione	Permitted 70 µm, (in case of low viscosity 20 µm) / Permeso 70 µm, (in caso di bassa viscosità 20 µm)	

*Depending of viscosity. In base alla viscosità

**For lower viscosity (according to ISO 8217 fuel standard) please contact Settima. Per viscosità minori (ISO 8217) contattare Settima.

Settima products for marine application

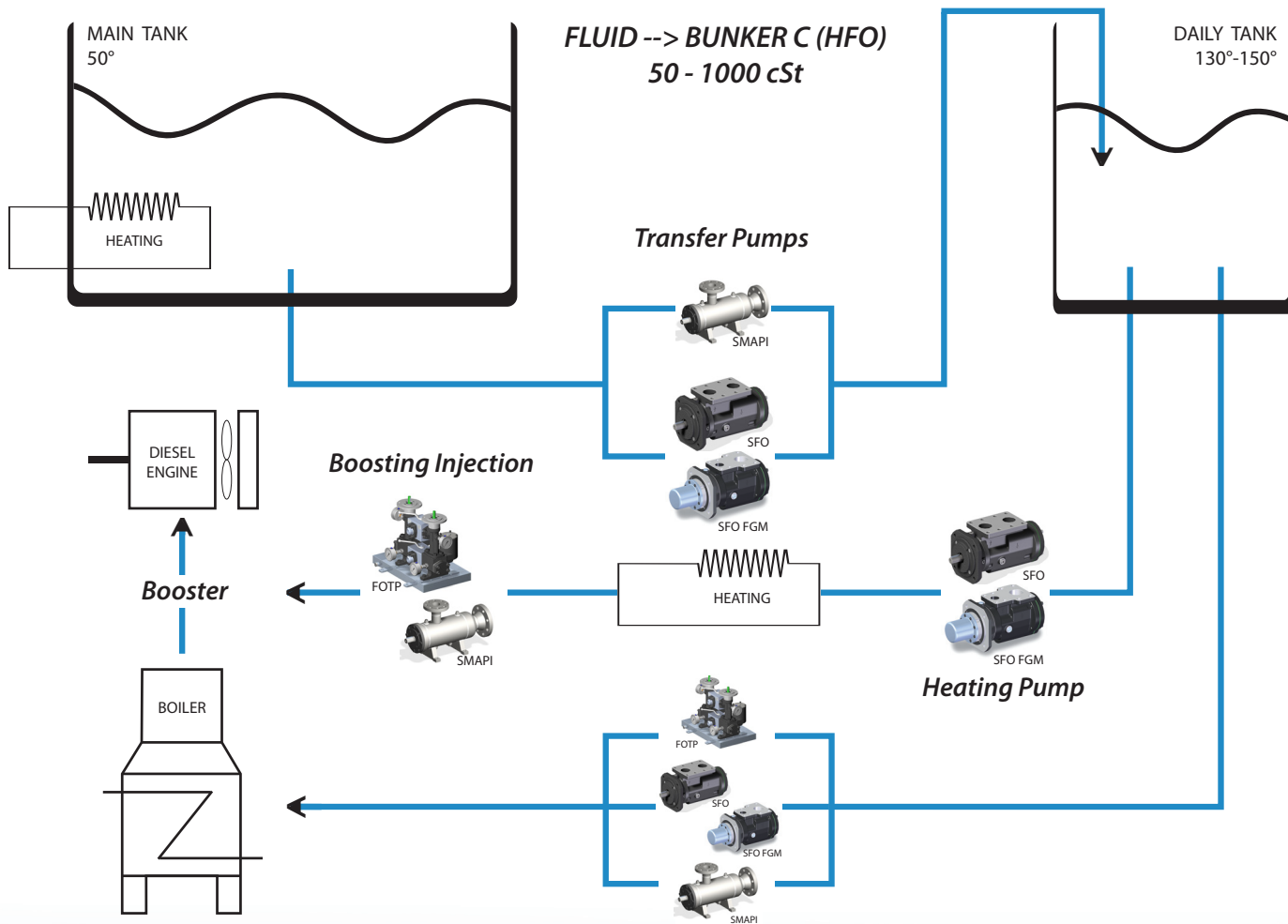

Product range - Ordering code of SFO pumps

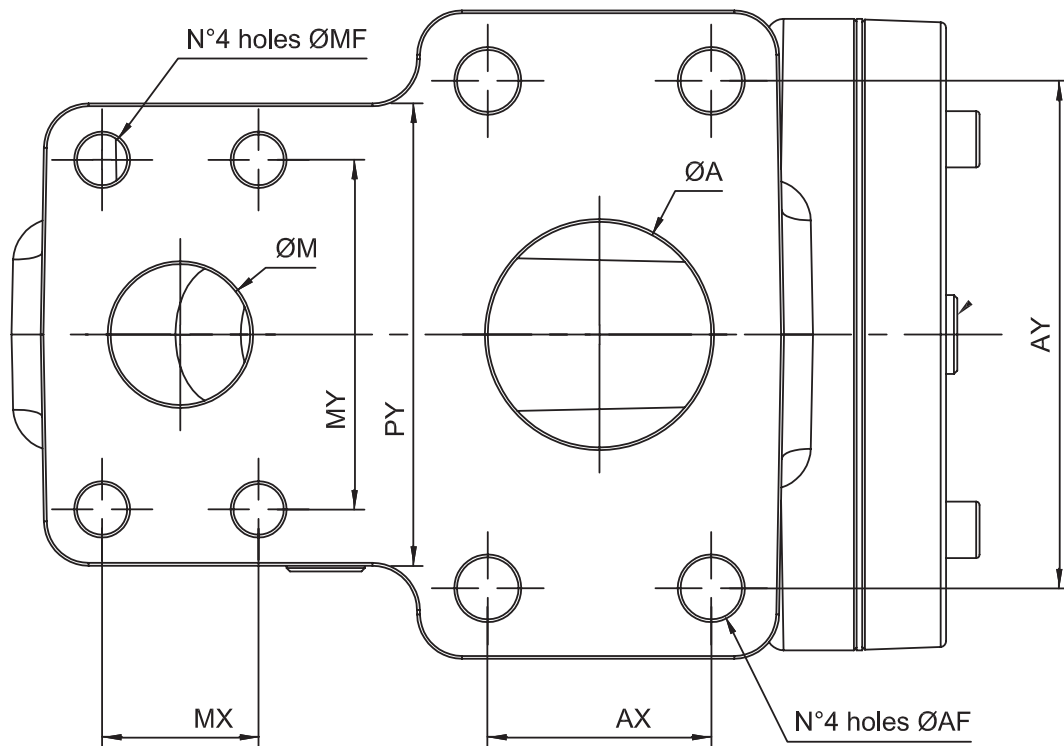

ORDERING CODE

Type Tipo	Class Classe	L/min	Seals Guarnizioni	Rotation Rotazione	Ext. adjustable relief valve - Valvola di sicurezza regolabile
GR 25	SFO	25L	Standard TM FO	Standard DX clockwise	Standard none
		30L			
GR 32	SFO	35L	* Optional FGM	* Optional SX counter clockwise	Optional RP
		45L			
		55L			
GR 40	SFO	75L			
		100L			
		125L			
		150L			

PORT DIMENSIONS

Discharge Mandata			Suction Aspirazione		
M	MX	MY	A	AX	AY
25	28	62	25	28	62
25	28	62	40	40	90
40	40	90	40	40	90

To request pump varnishing, please write it in your order. Per richieste di verniciatura, riportarlo sull'ordine.

To request the dispenser for seal guard, please write it in your order. Per richieste del sistema di sbarramento e circolazione, riportarlo sull'ordine.

To request SAE 3000 connections, please write it in your order. Per richieste di connessioni SAE 3000, riportarlo sull'ordine.

*Please contact Settima for the above options. Contattare Settima per le opzioni.

SFO pumps - Dimensional drawing

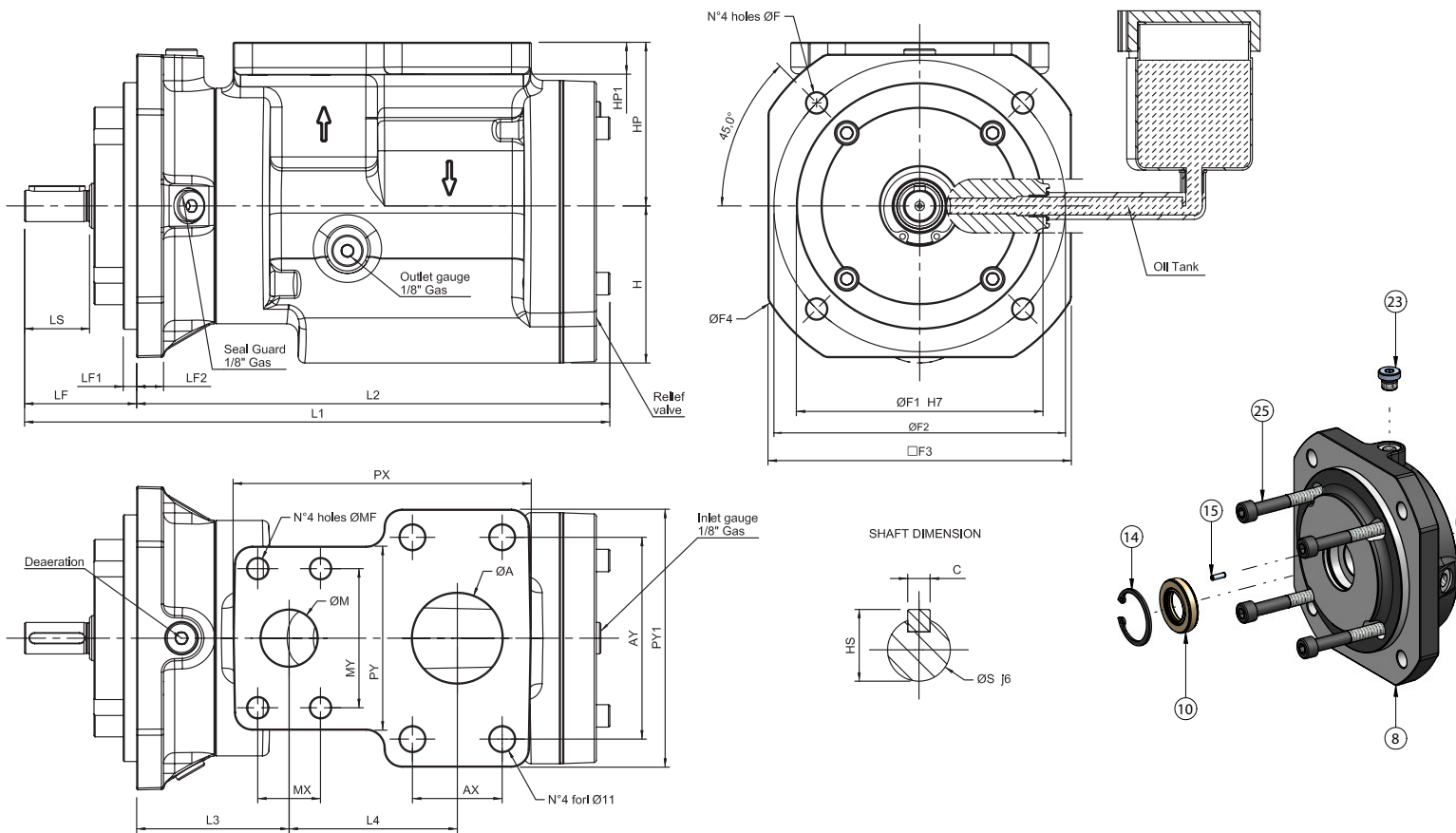

Pump / Pompa

	L/min	L1	L2	L3	L4	H	HP	HP1	PX	PY	PY1
GR 25	25-30	253	203	60	60	70	73	13	133	82	82
GR 32	35-45-55-75	261	211	68	75	70	73	13	133	82	115
GR 40	100-125-150	306	256	75	85	70	83	15	151	114.5	114.5

Flange / Flangia

	F	F1	F2	F3	F4	LF	LF1	LF2
GR 25	9	110	130	135	160	50	6	12
GR 32	9	110	130	135	160	50	6	12
GR 40	11	120	145	144	169	50	6	15

Discharge / Mandata

Suction / Aspirazione

Shaft / Albero

	M	MX	MY	A	AX	AY	S	C	HS	LS
GR 25	25	28	62	25	28	62	14	5	16	29
GR 32	25	28	62	40	40	90	14	5	16	29
GR 40	40	40	90	40	40	90	19	6	21.5	34

Product description

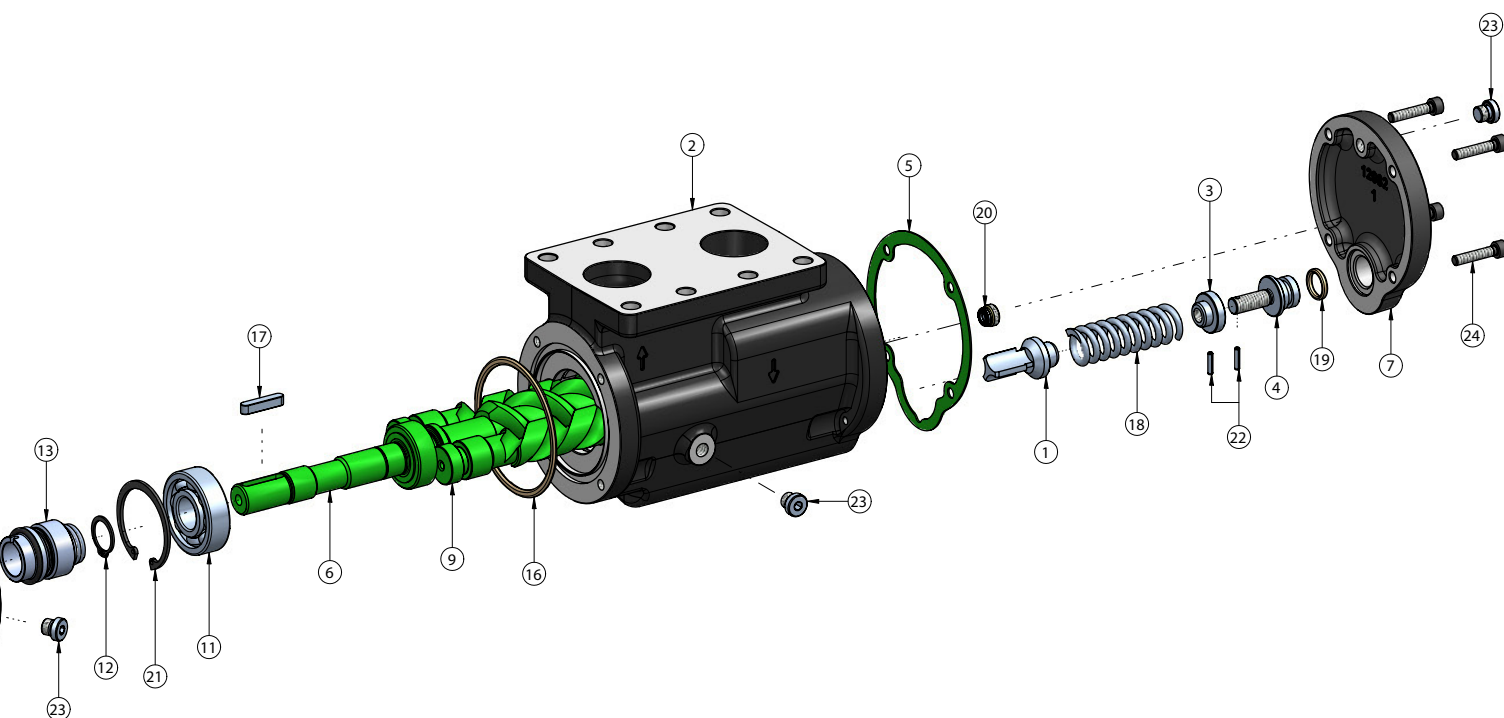

POS / N°	OBJECT / TITOLO	MATERIAL / MATERIALE
1	Shutter / Otturatore	Steel / Acciaio
2	Body / Corpo pompa	Cast iron / Ghisa
3	Push spring / spingimolla valvola	Steel / Acciaio
4	Regulation valve / Grano valvola	Steel / Acciaio
5	Plane gasket / Guarnizione piana	Fasit
6	Main screw / Vite centrale	Steel / Acciaio
7	Suction flange / Tappa	Cast iron / Ghisa
8	Flange / Flangia	Cast iron / Ghisa
9	Idler screw / Vite laterale	Steel / Acciaio
10	Seal ring / Anello di tenuta	FKM
11	Ball bearing / Cuscinetto	Steel / Acciaio
12	Circlip / Anello elastico	Steel / Acciaio
13	Meccanical seal / Tenuta meccanica	
14	Circlip / Anello elastico	Steel / Acciaio
15	Plug / Spina	Steel / Acciaio
16	Seal ring / Anello O-Ring	FKM
17	Key / Linguetta	Steel / Acciaio
18	Spring / Molla	Steel / Acciaio
19	Seal ring / Anello O-Ring	FKM
20	Check valve / Valvola ritegno	Steel / Acciaio
21	Circlip / Anello elastico	Steel / Acciaio
22	Plug / Spina elastica	Steel / Acciaio
23	Seal plug / Tappo cilindrico tenuta	Steel / Acciaio
24	Screw / Vite	Steel / Acciaio
25	Screw / Vite	Steel / Acciaio

Performance @1450 rpm

POWER (Kw)

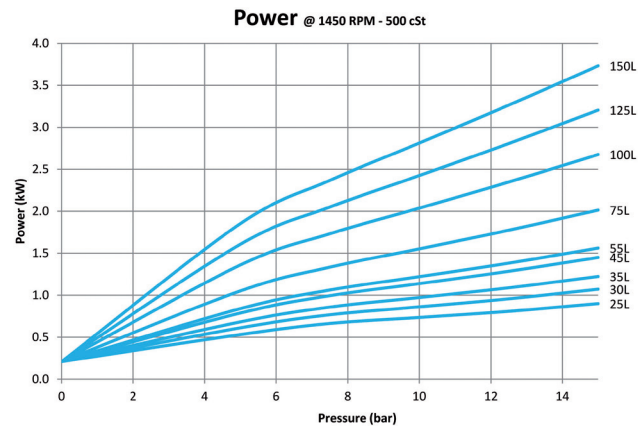
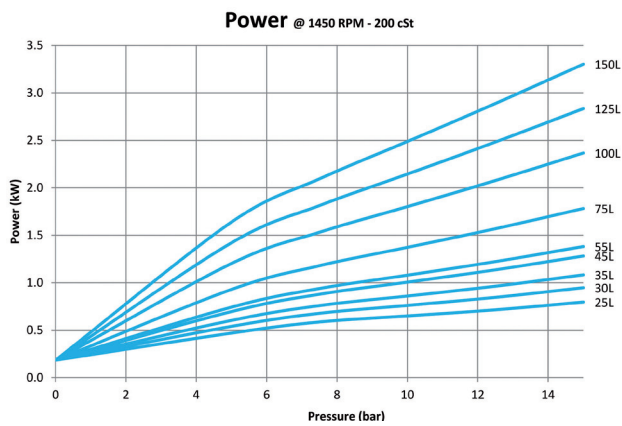
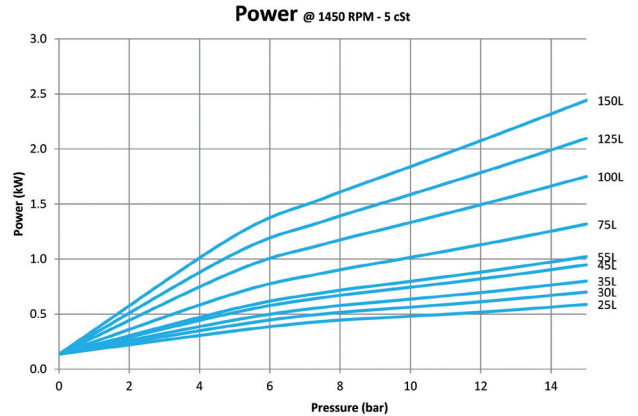
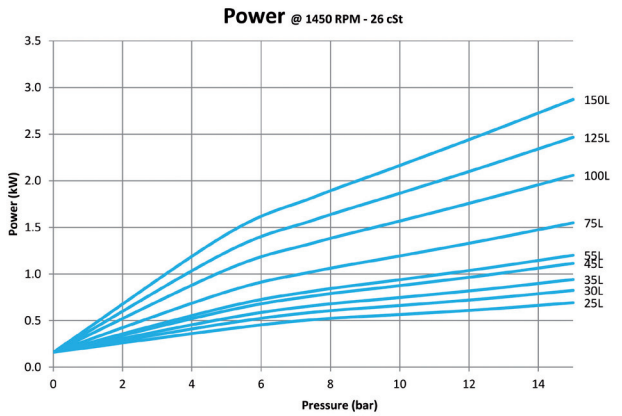

FLOWRATE (L/min)

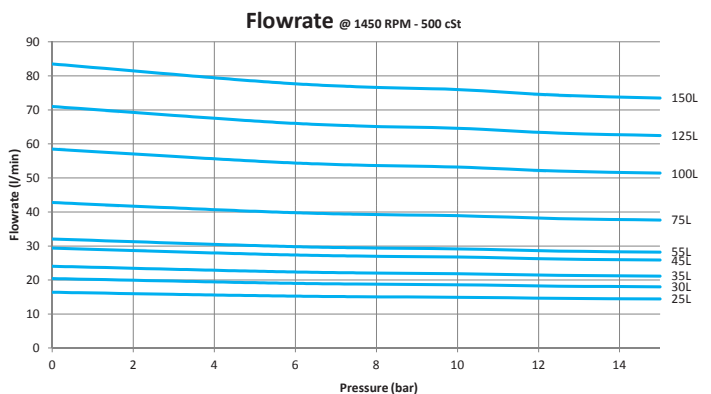
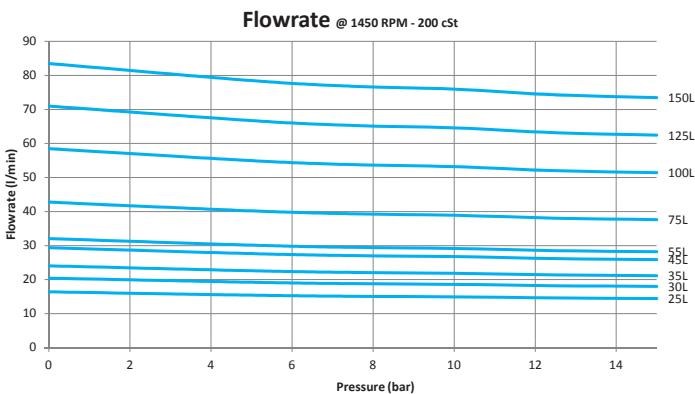
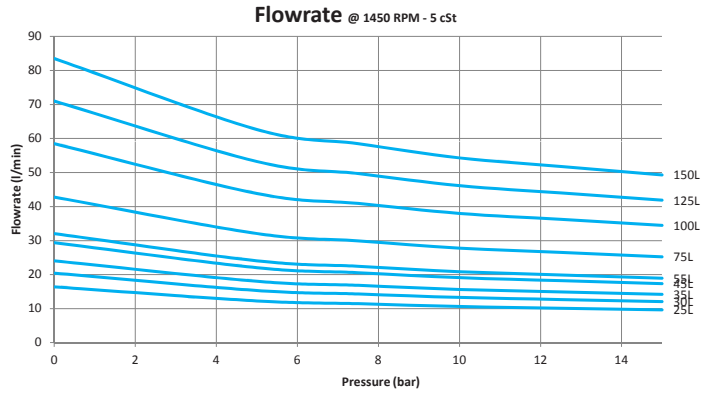
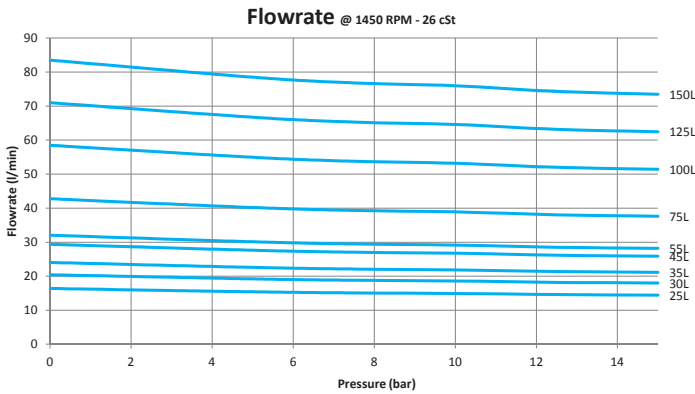

Performance @1750 rpm

POWER (Kw)

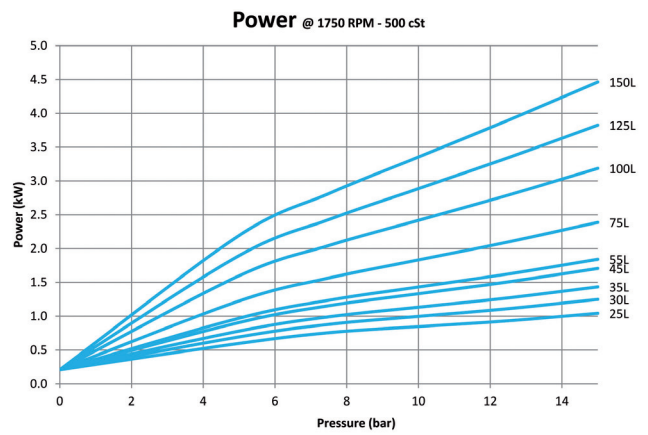
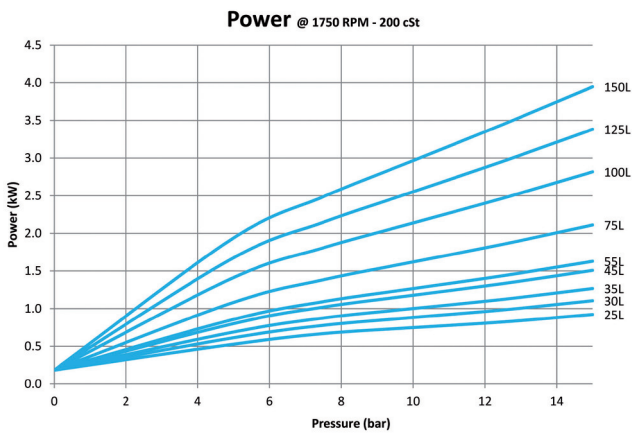
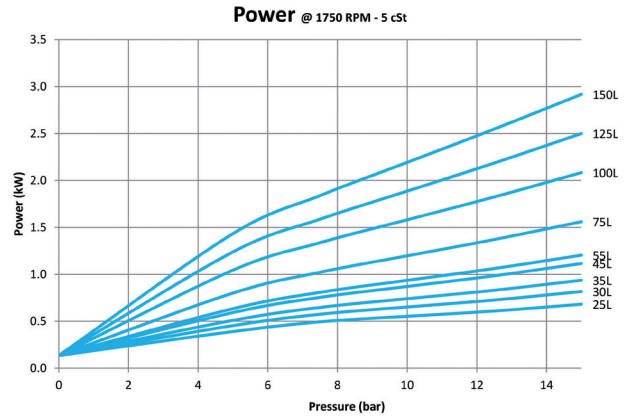
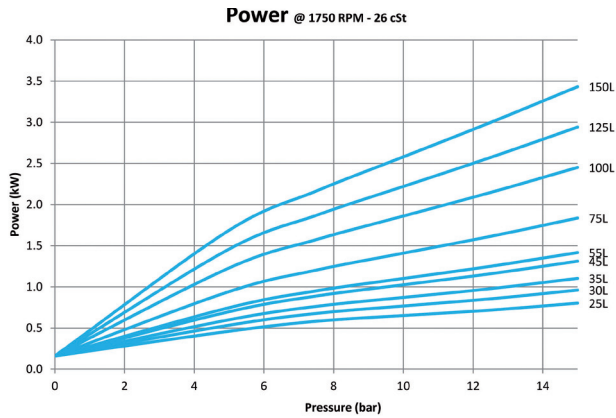

FLOWRATE (L/min)

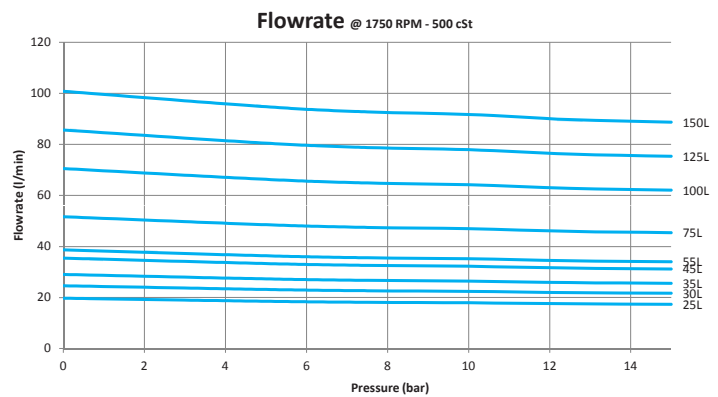
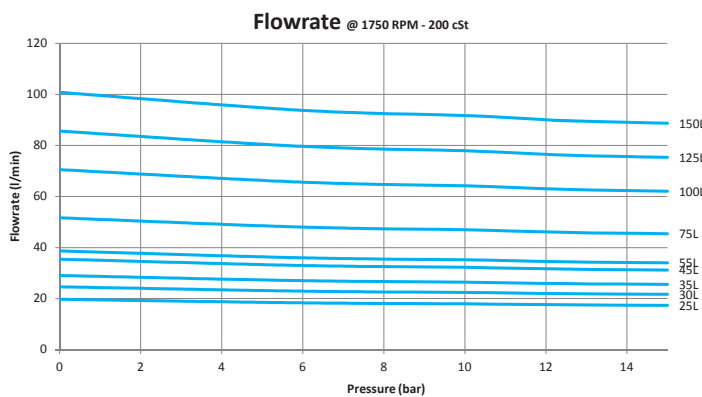
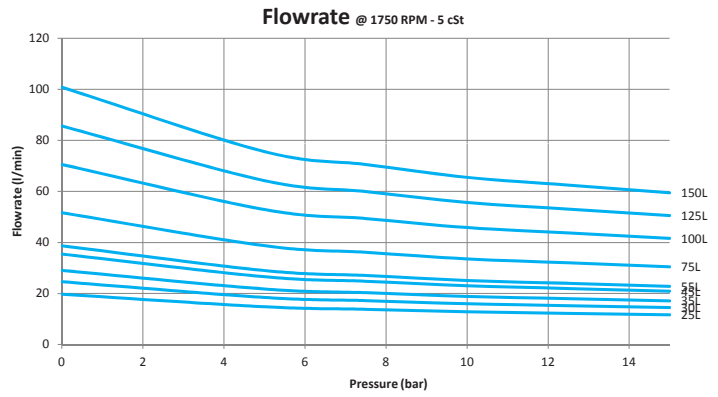
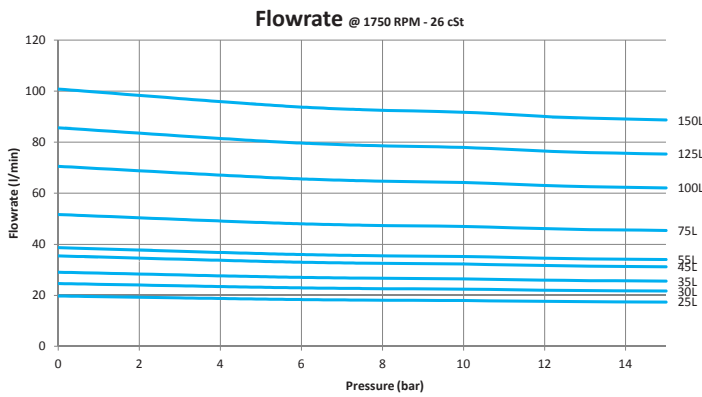

Performance @2950 rpm

POWER (Kw)

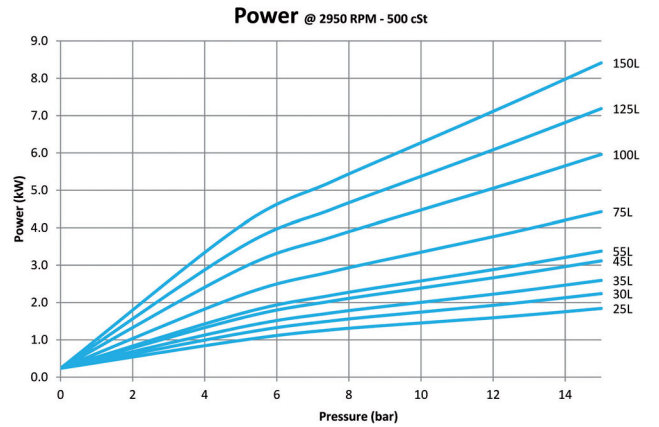
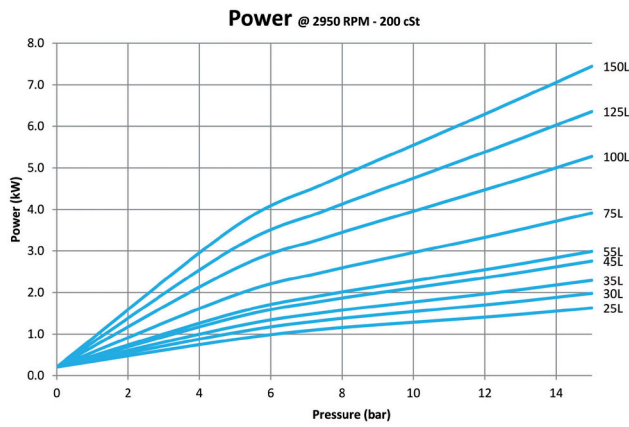
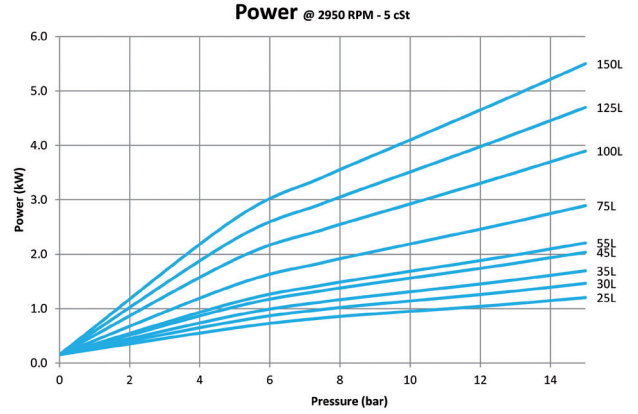
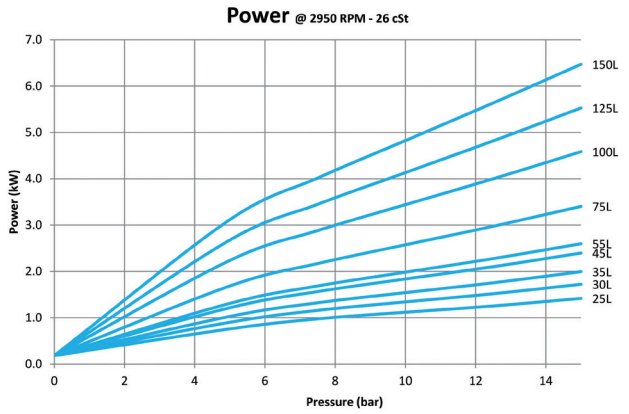

FLOWRATE (L/min)

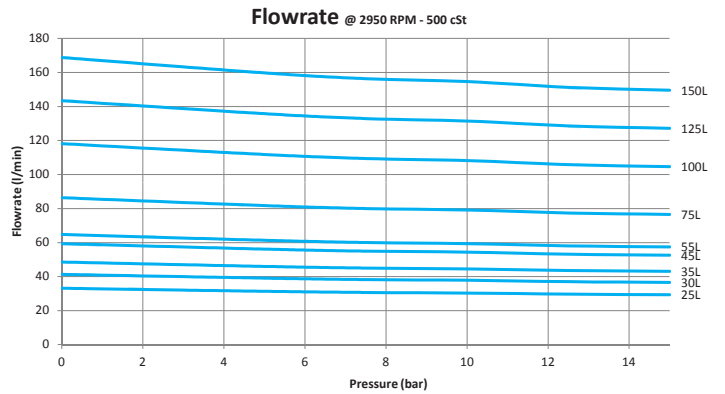
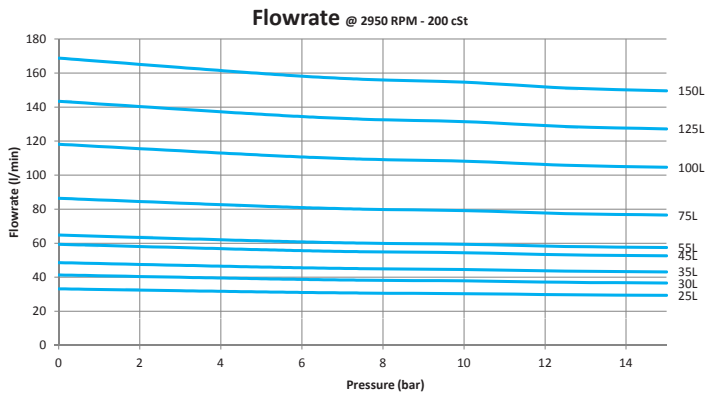
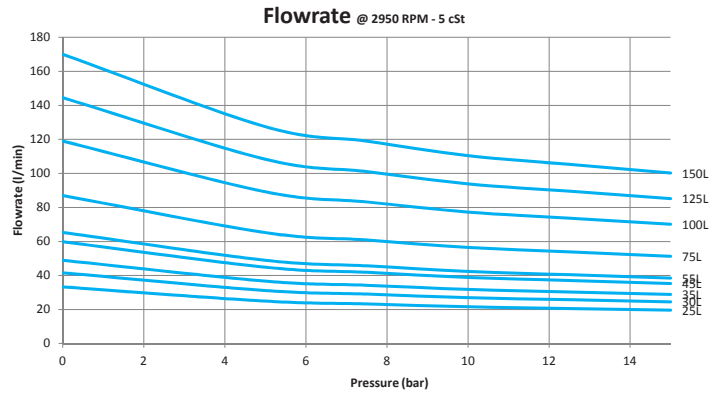
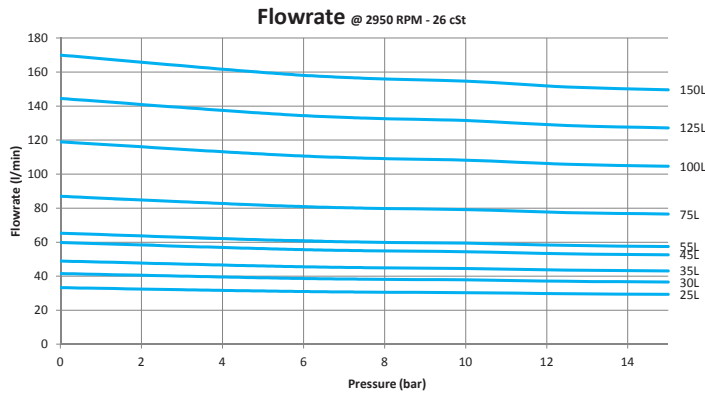

Performance @3550 rpm

POWER (Kw)

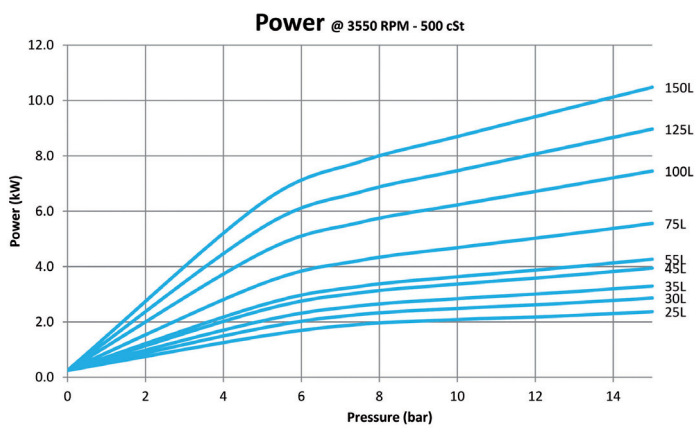
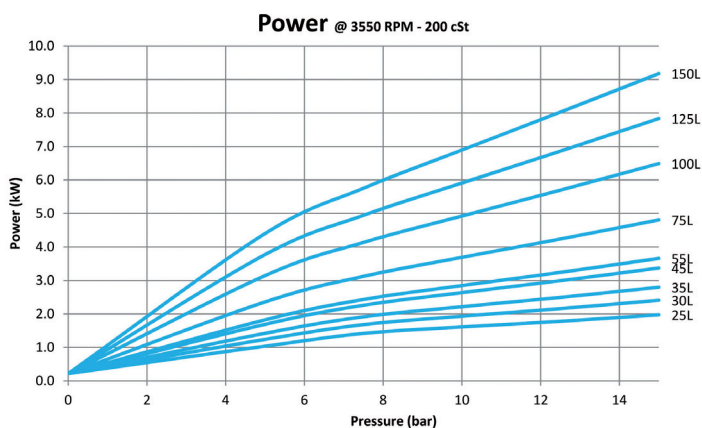
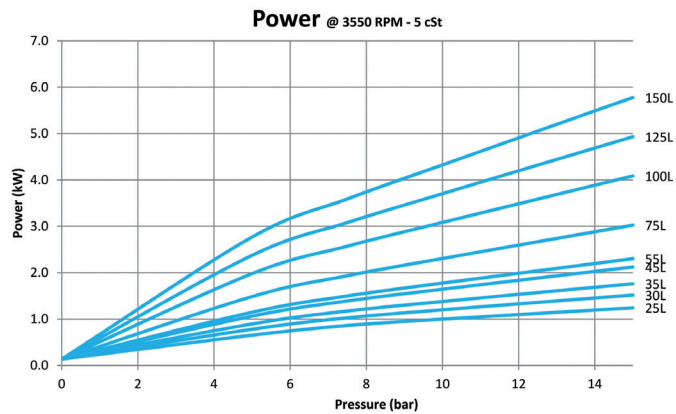
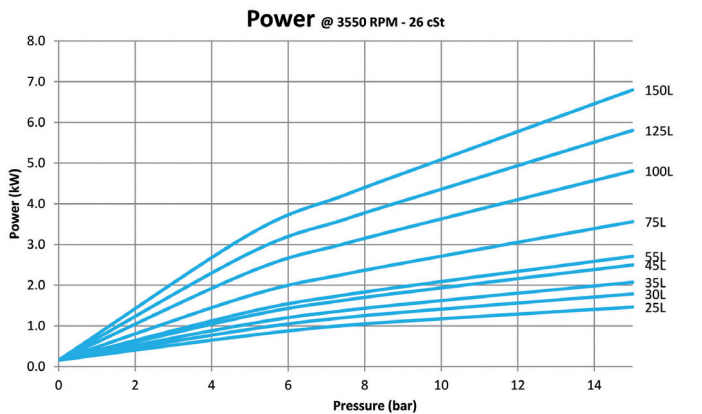

FLOWRATE (L/min)

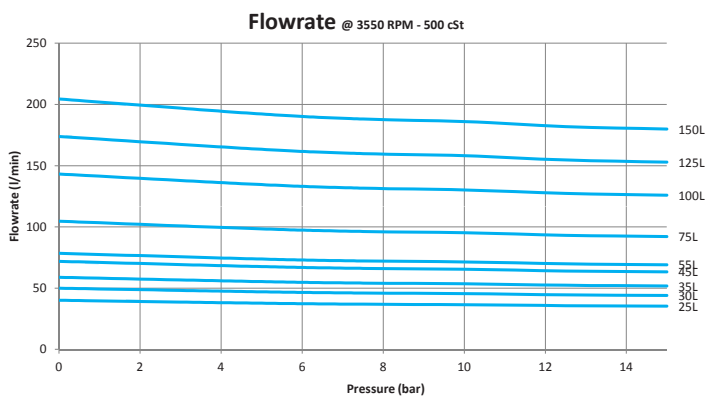
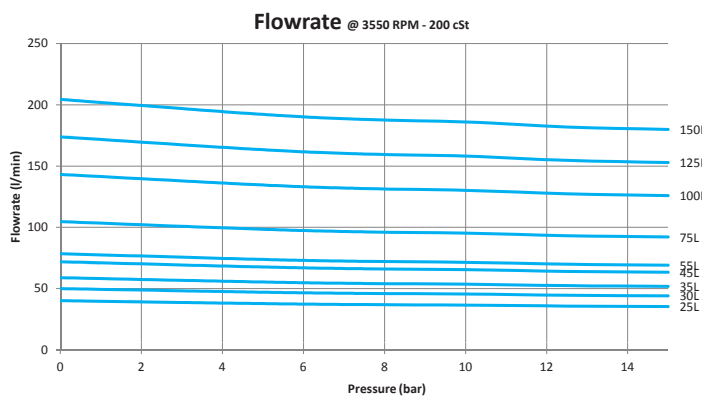
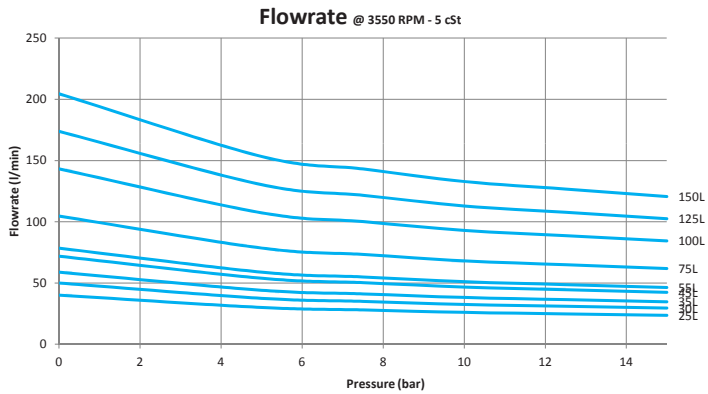
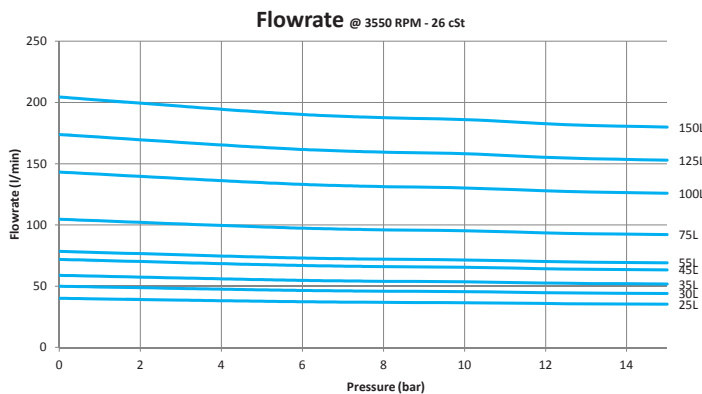

SETTIMA

Settima, Italy
Headquarter, r&d and production

SETTIMA

USA
Warehouse

SETTIMA

Shanghai, China
Warehouse

Settima Meccanica Srl
Settima - 29020 Piacenza (Italia)
tel. +39 0523.557623
fax +39 0523.557256
www.settima.it
info@settima.it

Settima Flow Mechanisms
Settima - 29020 Piacenza (Italia)
tel. +39 0523.557623
fax +39 0523.557256
www.settima.it
info@settimafm.com

 **SETTIMA MECCANICA**

Area Agency/Reseller

SETTIMA 
flow mechanisms